



Diversity in profiles.

Braselmann is a profile rolling mill with more than 125 years of experience in metal processing. Specializing in cold rolled profiles, we produce a sophisticated product range, from standard profiles for roller shutters to complete roller shutter doors. In addition, we develop special profiles for a variety of purposes, using our own tool-making department.



Frank Braselmann
General Director



We get your business rolling.

Braselmann stands for maximum precision, quality and cost effectiveness in cold rolled profiles. Customers at home and abroad profit from in-depth knowledge, the latest production methods and close cooperation.

Profile design, tool-making, manufacturing and roller shutter assembly – all under one roof.

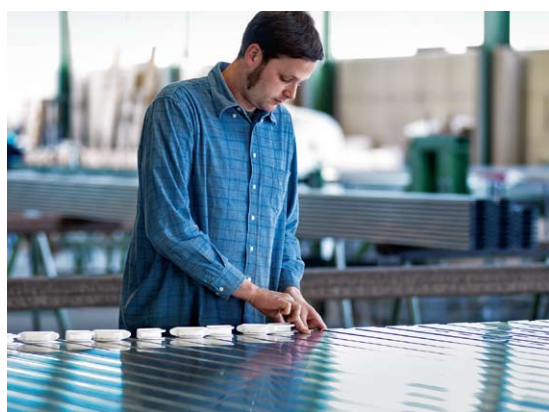



The doorway to success:
Individual solutions from
small doors to 33 meter
wide hangar doors.



Quality in every relationship

The quality standards with which the merchant Ferdinand Braselmann established his ironmongery sales and manufacturing company in 1884 remain the basis of our business activities. These standards apply to both the quality of our products and manufacturing methods and the quality of our relationships with customers. Success only comes to those who continuously contribute to the success of others. Following this principle, we have developed our family company into an efficient manufacturer of high quality roller shutters and special profiles that enjoys national and international trust.

Expertise to meet every customer requirement

In the course of over 75 years, our company has built up a valuable body of experience in the cold forming field and advanced numerous innovations. Extensive knowledge about application requirements, material properties and outstanding craftsmanship go into the design of every profile. Our in-house tool-making capacity and the latest production methods guarantee precise, economical implementation of special customer requirements. As a system supplier, we design and manufacture complete roller door systems and also offer high quality, reliable individual solutions.

Personal consultation, close cooperation and first-class results. That's what matters to us. We are proud to be a family business.

Frank Braselmann

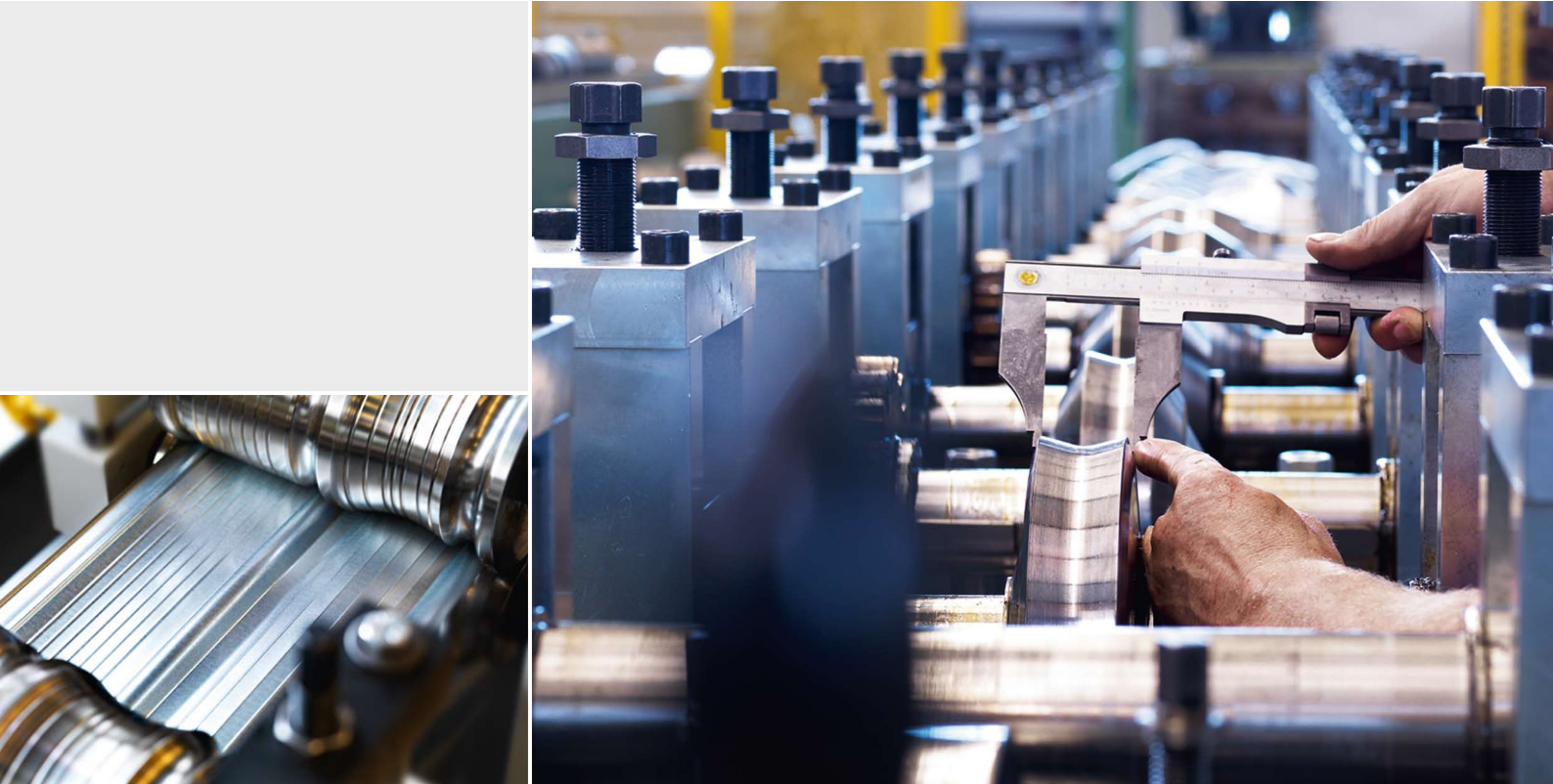

Open and close and open and close and open and close ...

A good roller shutter is expected to provide trouble-free operation over a long period. The perfect design and precision production of Ferdinand Braselmann's profiles are an important factor in this.

The finest materials for long term use

Roller shutters in Braselmann's cold formed profiles are extremely robust, durable and attractive. In addition to the design, careful material selection and surface finish are decisive for stability, quietness of operation and appearance. We only process first class raw materials such as galvanized sheet steel, aluminium or stainless steel obtained from leading manufacturers.



All new profile designs are exhaustively tested on our own test bench.

Precise structural wind load calculation

Stability under wind load is the most important requirement for roller doors. That is why we have developed a certified computer program for calculation of loading and deformation of roller shutters under wind load, with or without storm hooks, in collaboration with the Institute for Structural Design at RWTH Aachen University. It allows us to exactly determine maximum possible door dimensions at different wind velocities.

Everything goes onto the test bench

Before new materials and profile types are used, they are subjected to extensive internal and external testing. In particular, the heat and sound insulating properties of our profiles are verified by appropriate certification. We also supply shot, explosion or break-in resistant roller shutters; naturally, with the required certificates.

Integrity from materials selection to tool-making, production and the final product. That is our principle and our responsibility toward our customers.

Thomas Voigt
Technical Director



The roller door on the side of this supply ship shows the numerous application possibilities for roller doors. Here, it acts as the door to a garage for a mini-submarine.



Roller doors open up diverse opportunities – whether as movable walls in rack storage or design surfaces in corporate design.

With us, top quality is standard.

Our product range offers a variety of single and double-walled roller door profiles for industrial and private applications. Materials, design and colour selection permit a large range of combinations and the realisation of unique ideas. They all have rock solid design in common.

The tough ones: Single-walled roller door profiles

Our single-walled roller door profiles are available in galvanised steel, aluminium and stainless steel, colour coated upon request. They prove to be extremely robust and resistant to bending in everyday use. The selection includes curved and straight profiles in different materials and surfaces.

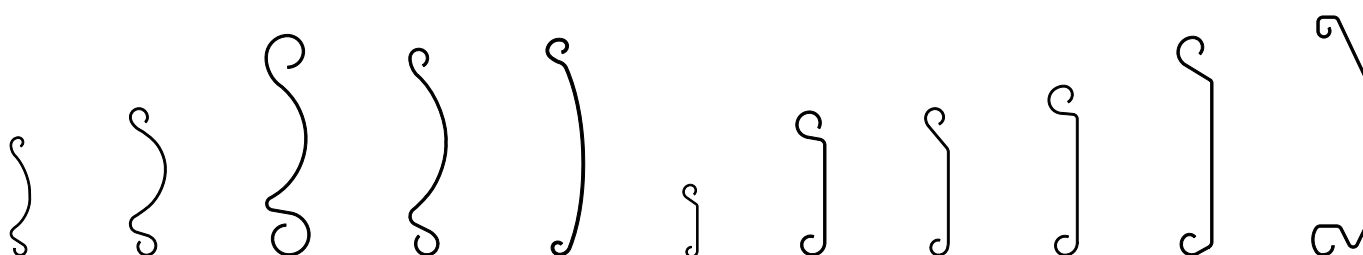



The variety of profile styles and unlimited colour choices allow roller shutter doors to provide architectonic accents.



The convenient ones: Double-walled roller door profiles

We recommend our double-walled roller door profiles where requirements for smooth operation and insulating properties are higher. Depending upon model, they are provided with polystyrene foam, mineral wool or filled with polyurethane foam in a modern production process and satisfy the highest demands for stability, resistance and safety. They are also available in different materials and colour coatings.

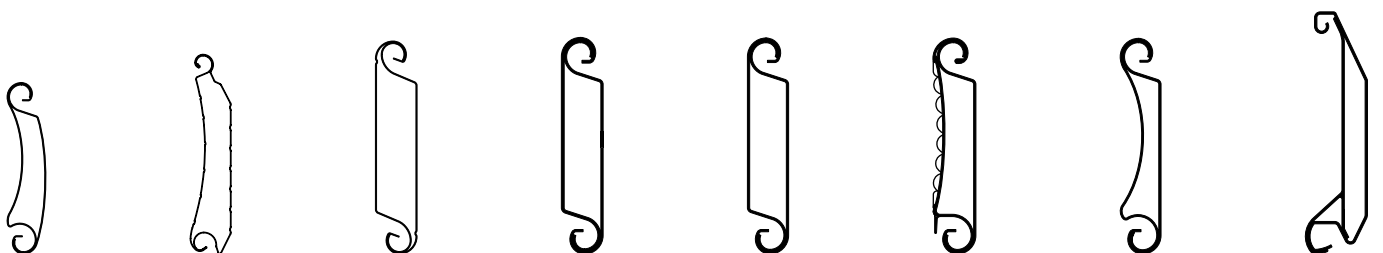



Perforated, grid and window profiles provide an open appearance and higher security through good vision in the direction of the bright side.

Good visibility, maximum security.

To allow visibility when the roller door is closed or to provide better ventilation, different apertures and cut-outs can be incorporated in the profiles. An attractive appearance and satisfaction of high security requirements do not have to be contradictions in roller doors.

Window on the yard: Perforated, grid and window profiles

Most of the profiles in our product range are available in versions as perforated or window profiles or with grid cut-outs. In addition to better vision and ventilation, they also provide a visual lightening of the roller shutter. Existing roller door installations can be retrofitted accordingly or partially upgraded.



1.155L perforated profile



1.144L perforated profile



1.1620 window profile



1.95 R window profile

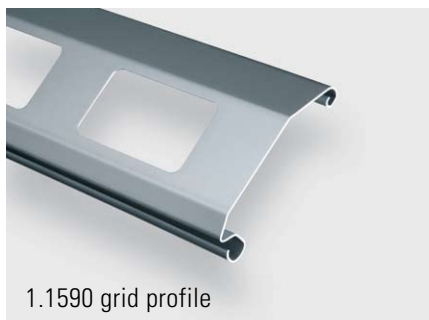

1.1590 grid profile



1.95 R ventilation grid

Security with style:
TranspaSafe metal
profiles are available
in bright or anodised
aluminium and every
RAL colour.

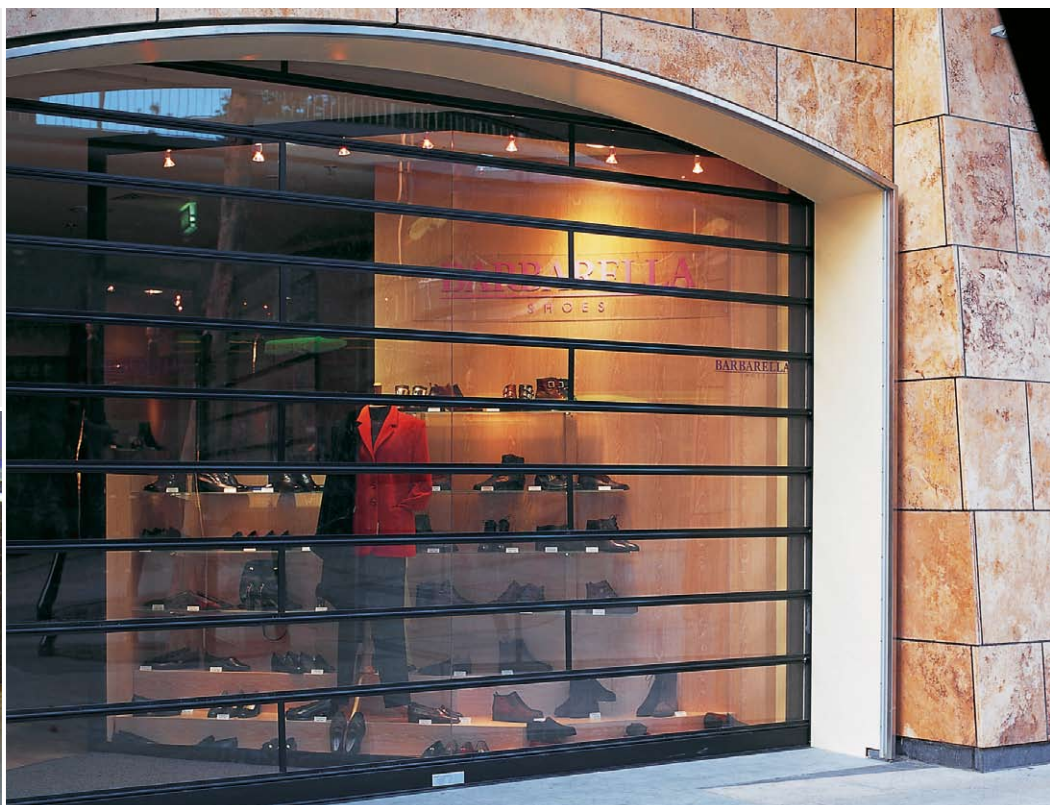

The fusion of security and elegance. TranspaSafe

Braselmann offers the TranspaSafe roller door, which is also protected against vandalism, specially for high quality fittings of shops and shopping centres. The large panes consist of impact and scratch-resistant polycarbonate and are equipped with a special coating against paint spray.



TranspaSafe

The special winding technique protects the window elements from damage.



Perfectly designed and fully wrapped.

Numerous partners take advantage of our expertise as systems suppliers for complete roller door construction sets. These are designed and delivered pre-assembled in accordance with individual requirements – tailor-made, expert solutions from a single source.

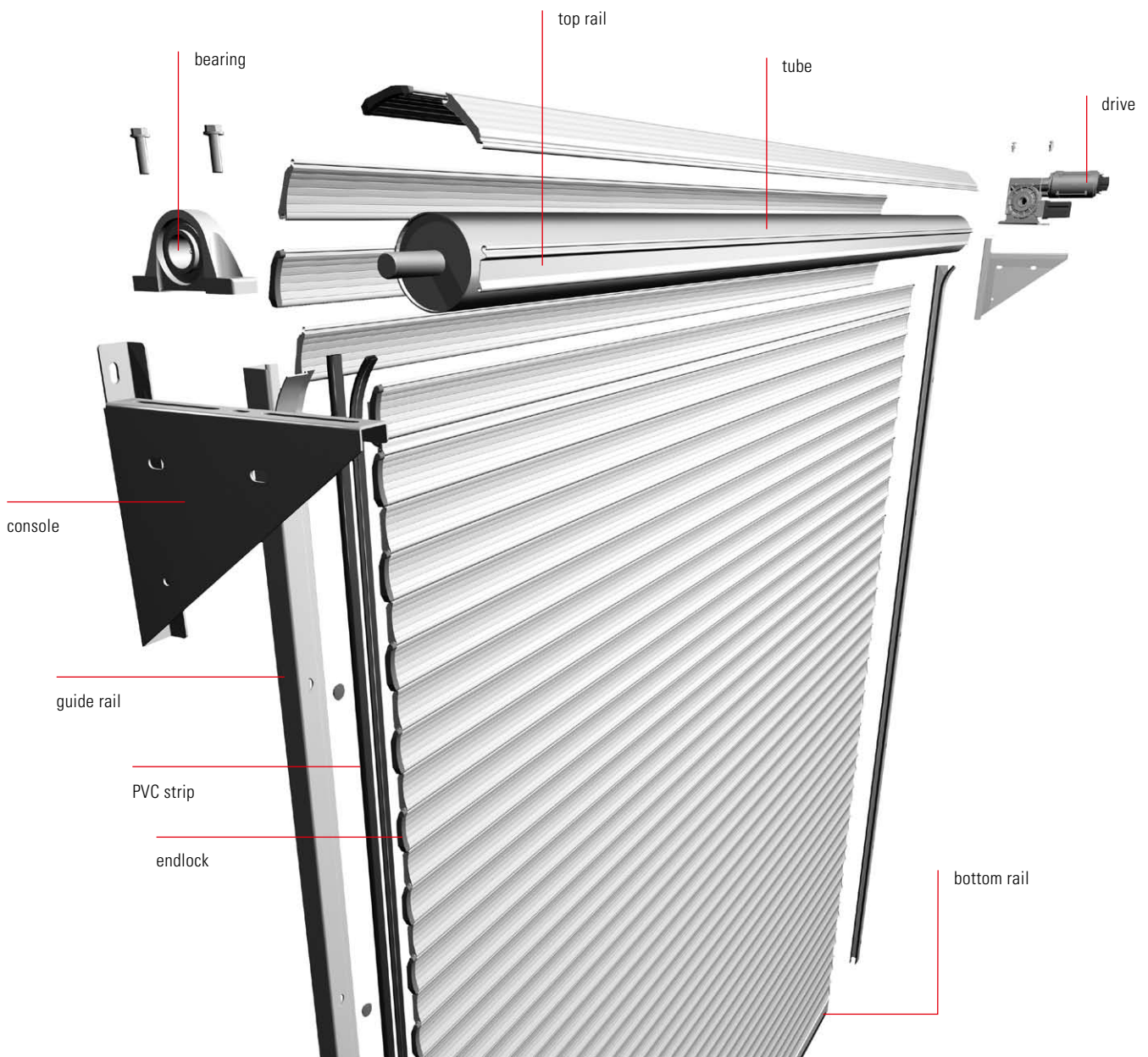

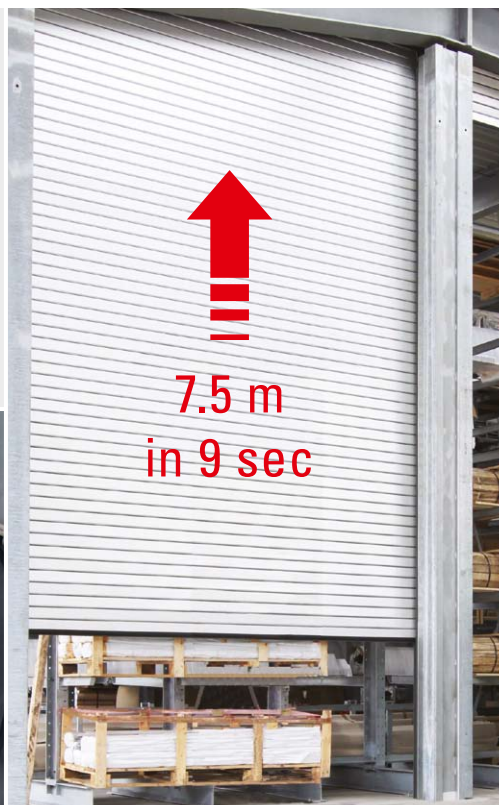
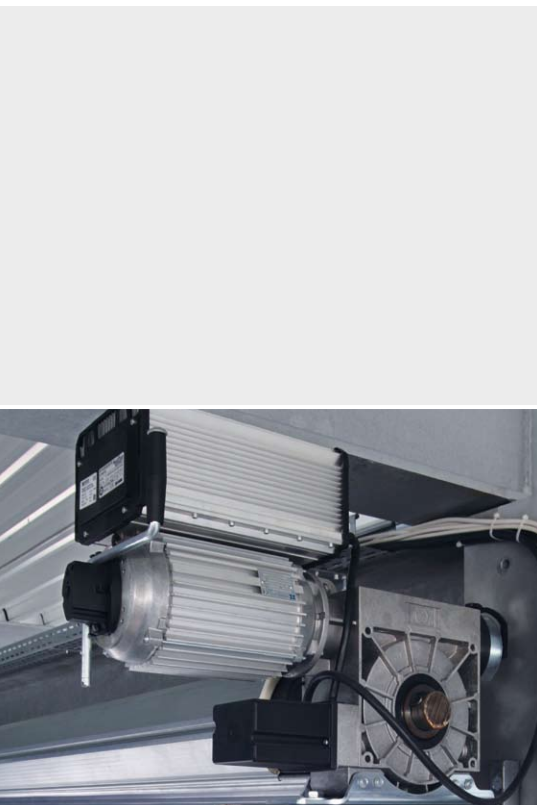

In the pole position with Braselmann: High-speed doors optimise operating procedures and reduce heat loss.

Complete and cost-effective: Standard roller shutter door

More and more Braselmann customers choose the most convenient solution. We supply them with economical, tailor-made, complete construction sets for roller shutter doors with the profile of their choice. All shipped systems comply with DIN EN 13241-1, which is documented in corresponding test certificates.

Opening and closing at high speed: High speed roller shutter door

In addition to standard systems, we also supply complete construction sets for high-speed roller shutter doors with achievable average speeds around 0.9 m/s. The double-walled ISO-SL roller door profile with patented hard/soft PVC inner shell offers particular advantages. It is distinguished by greatly reduced running noise and outstanding heat insulation.



Quality from a single source: Complete, tailor-made roller door.

Trained eye for details:
Brasermann experts
develop high-quality,
cold-rolled profiles
for every purpose.

The quality of a
manufacturer is
revealed in the
quality of the
smallest accessory.



The perfect complement: Accessories for roller doors

A chain is only as strong as its weakest link, a roller door only as reliable as the required accessory. We therefore also pay attention to every detail of end pieces, bottom and top rails, guide rails, reinforcement angles and storm hooks. So that everything rolls smoothly for our customers.



1.1369 guide rail



1.100 D stormhook with rolls



1.100 D top sealing lip



reinforcement console

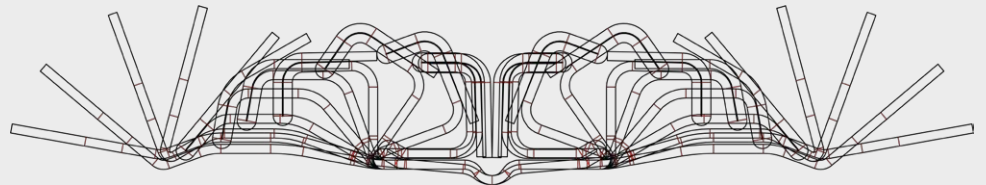

The masters of flowers.

At customers' request, our designers not only develop high-precision, special profiles for roller doors, but many other applications. The drawing of an unfolded profile design called a "flower" makes all the shaping steps visible.

As unique as the challenge: Special profiles

Special requests are our specialty because in our company the design and tool making departments work hand-in-hand. Our experts are in a position to create even unusual profiles. Taking the particular application requirements and most efficient production methods into account, they develop optimal solutions that can be protected exclusively for the customer. We produce profiles up to 200 mm in width and 100 mm in height in lengths between 40 and 30,000 mm. A large selection of materials in different thicknesses is available:

- Steel: bright, galvanised or colour-coated
- Stainless steel: Grades from 1.4016 to 1.4571, surfaces bright-rolled, polished, brushed, ground, with full or partial film
- Aluminium: bright, anodised or colour-coated

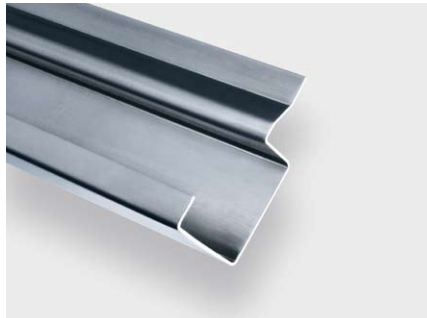



Metal in the genes. A history.

Braselmann is a family business that has been at home in metal processing for over 125 years. A large variety of cold rolled profiles have been produced since the 1930s, while design, tool-making and manufacturing have been continuously developed.

- April 1884 Ferdinand Braselmann founds a trading and commission business for ironmongery.
- 1887 The drop forge begins production of ironmongery on his parents' farm.
- 1892 – 1918 The business converts to the production of horse fittings. The company thrives from the turn of the century until the First World War.
- 1931 Special eyebolts and nuts are manufactured to DIN standards for the mining and automotive industries.
- 1933 The first cold rolled profiles are produced.
- 1955 The company develops and produces the patented car jack that is part of the VW Beetle's equipment.
- 1960 Eckhart Braselmann develops and produces the first double-walled roller door profile.
- 1975 The drop forge and profile rolling mill become legally independent companies.
- 2004 The programme developed by Braselmann and RTWH Aachen University for calculation of loading and deformation of roller door shutters under wind load is certified.
- 2005 Braselmann delivers completely prepared and pre-assembled roller door systems for the first time.
- 2011 The extremely quiet ISO-SL high speed roller door profile with patented hard / soft PVC inner shell is launched.

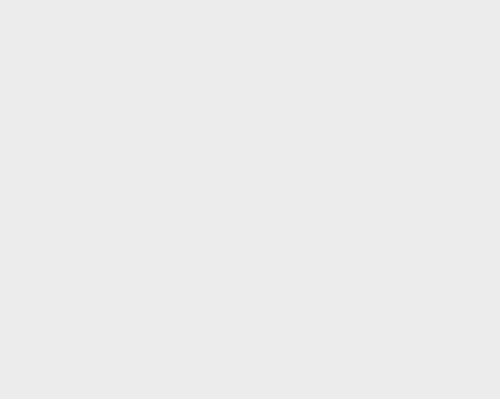
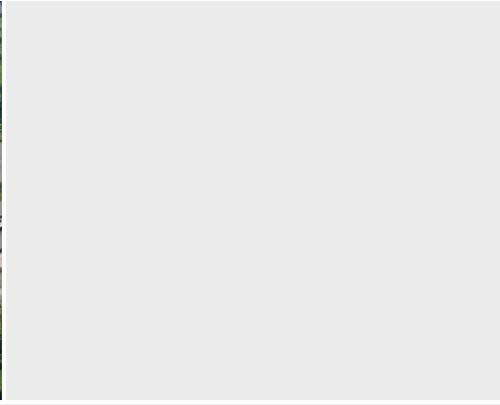

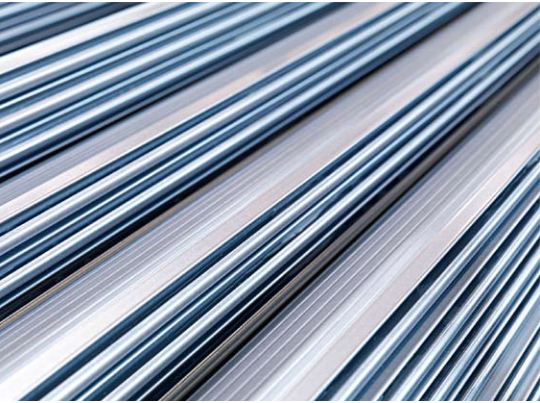

Ferdinand Braselmann
GmbH & Co. KG
Profilwalzwerk

Kotthausstraße 15–23
58256 Ennepetal

Fon +49 (0) 2333 798-0
Fax +49 (0) 2333 798-55

info@braselmann.de
www.braselmann.de

Design: www.gute-botschafter.de

ferdinand
braselmann.de